

FWT 1500 x 750

Operating Instructions



Welding table



Dear reader,

Introduction

These operating instructions will help you familiarise yourself with the welding table. It is in your interest to read these instructions carefully and to observe the directions contained herein. This will prevent faults and incorrect operation or possible damage to installed system components.

Please also obey the safety rules; doing so will ensure greater safety when using the product. Careful handling of the entire system will repay you with years of safe and reliable operation. These are essential prerequisites for excellent results.

Table of contents

General information	3
About this document.....	5
Function of this document	5
Qualified technicians	5
Copyright.....	5
Safety	7
Operational reliability and tips for the user	9
Proper use.....	9
Operating instructions	9
Duty to instruct	9
Third-party and untrained personnel	9
Additional safety measures	10
Description	11
Danger points	13
Danger points	13
Description of the danger points	13
Residual risk.....	13
Transport and storage	15
Handling and transporting items	15
After delivery	16
Temporary storage	16
Transport and setup	16
Overview	18
Machine data	18
Description of controls and connections.....	19
Safety	19
External controls and connections	19
Maintenance unit.....	19
Distributor.....	20
Extractor.....	20
Compressor.....	20
Installation and start-up	21
Start-up.....	23
Properties of the installation site	23
Space requirements	23
Troubleshooting and maintenance	25
Troubleshooting.....	27
General.....	27
Safety	27
Basic requirements for the system to work	27
Maintenance, service	28
Safety	28
Maintenance engineers.....	28
Maintenance operations and intervals	28
Recommended lubricants	29

Spare parts & accessories 30
 Ordering
 details 30
 Spare parts 30
 Accessories 31

Annex **33**

Declaration of conformity 35
Pneumatic plan 37

General information

About this document

Function of this document

These operating instructions tell you how to commission and operate the welding table in conjunction with the installed system components. Look after the operating instructions carefully; they must always be to hand at the location where the welding table is being used. They can be used as a reference should any operational or functional problems occur in the future.

Note: there are a large number of potential combinations of accessories, and for this reason you may find features described in these instructions that are not available on your welding table.

Qualified technicians

These operating instructions are designed for trained technicians or persons with practical welding experience. Personnel must be trained through a verifiable programme of regular instruction.

Maintenance and repair of the welding table may also only be carried out by trained technicians and in compliance with the specified maintenance activities and maintenance intervals.

The manufacturer accepts no responsibility for damages caused by insufficient knowledge of how to operate the system.

Copyright

Copyright of these operating instructions remains with Fronius International GmbH. The text and illustrations are all technically correct at the time of going to print. We reserve the right to make changes. The contents of the operating instructions shall not provide the basis for any claims whatsoever on the part of the purchaser.

Safety

Operational reliability and tips for the user

Proper use

The FWT 1500x750 welding table must only be used for welding demonstrations and training. Any other use shall be deemed improper and the manufacturer will assume no responsibility for any damages arising.

It can be used with the following welding processes:

- TIG process
- MIG/MAG process

Proper use also includes:

- following all the information in the operating instructions
- carrying out all maintenance work at the appropriate intervals
- using the spare parts stipulated by Fronius
- using this document in conjunction with the operating instructions of the integrated system components (extractor, compressor, etc.)

Operating instructions



The operating instructions help you to use the welding table safely and efficiently, and must therefore be to hand at all times.

- Keep the various sections of the operating instructions near the welding table at all times.
- Clearly mark the place where the instructions are kept
- Ensure that all persons using the welding table know where the operating instructions are located.
- The operating instructions will only be able to help you if you can find them when there is a problem!

Important! The manufacturer shall not be liable for any damage arising from failure to observe the operating instructions.

Duty to instruct

Before personnel start working with the welding table, the plant operator is obliged to instruct them about:

- the theoretical and practical aspects of using the welding table
- the relevant safety regulations.

Important! The duty to instruct applies in particular to those who only work occasionally on the welding table (e.g. maintenance engineers, etc.)

Third-party and untrained personnel

Do not allow third-party or untrained personnel unsupervised access to the welding table.

- Visitors or untrained personnel may only approach the welding table when accompanied by trained personnel
- Ensure that the welding table is never used unsupervised.

Operating pneumatic equipment

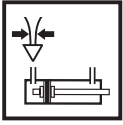

On welding accessories with integral pneumatic equipment, observe the following:

- The operating air pressure must not exceed 8 bar unless other operating pressure values are specified in the operating instructions.
- Contaminated compressed air shortens the service life of pneumatic components. A maintenance list for pneumatic components has therefore been included in the operating instructions.
- Keep the ambient air free from: dust, acids, corrosive gases or substances.
- Cylinders and other pneumatic components must only be dismantled by Fronius-trained service technicians.
- When commissioning, note that valves may have undefined switching positions. This may result in uncontrolled movements. Always remain at a safe distance!
- Before you start work on the pneumatic equipment, the compressed air should be switched off, the system vented, and measures taken to prevent it being switched back on.

Additional safety measures

The plant operator bears sole responsibility for the work environment. The following safety measures must be put in place and employed:

- Workplace must be enclosed
- Unless extraction and filtration equipment to reduce gas and vapour build-up is integrated, it should be specified by a specialist company and implemented by the customer.
- Eye protection must be worn when welding
- Workers must wear personal protective gear when welding

Description

Danger points

Danger points

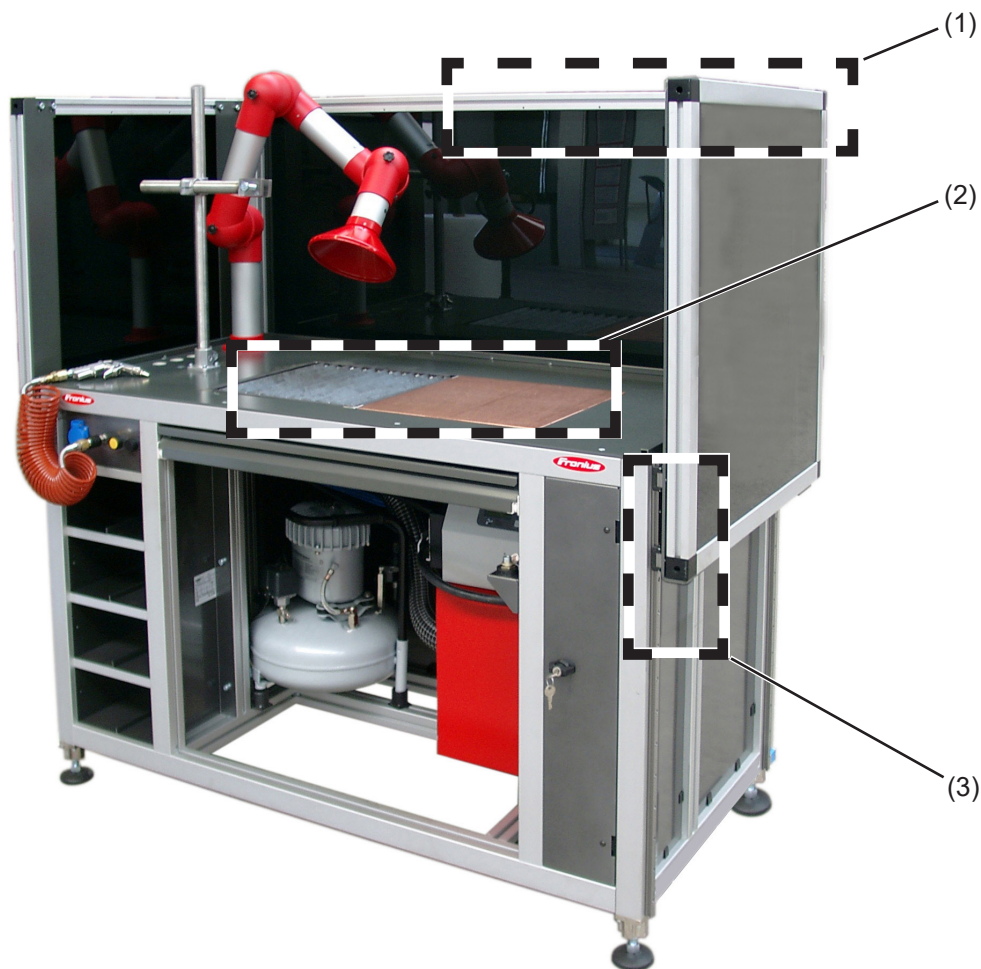

Description of the danger points

-
- (1) **Adjustable eye protector**
Danger of an unexpected movement. Personnel standing nearby should be warned before the eye protector is moved.
-
- (2) **Heat and hazardous fumes**
Personal protective equipment is mandatory for welding demonstrations. If there is no integrated fume extraction system (as illustrated above), then one should be retro-fitted by the plant operator.
-
- (3) **Adjustable eye protector poses risk of crushing**
Moving parts of the eye protector must not be touched under any circumstances.
-

Residual risk

if the eye protector is extended (as shown in the picture above) when storing the welding table for long periods, the eye protector will drop down due to the decrease in pressure that occurs in the system.

Transport and storage

Handling and transporting items









CAUTION!

Danger of damage due to incorrect handling of the transport boxes.

If required the welding table will be delivered in a secure transport box. This has various transport notices affixed to it.

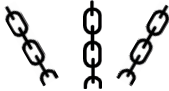
Observe the transport notices on the packaging or box.

Symbol	Explanation
	Protect from moisture! The shipping item must be kept dry.
	Keep upright during transport. Always store and transport shipping items with the arrows pointing upwards. Shipping items must not be laid on their side or upside-down. If these rules are not observed, the shipping item may be damaged.
	When lifting and transporting a shipping item, note its centre of gravity. When lifting, always hold the item as close to this point as possible. This will prevent it from tipping over unexpectedly.
	Fragile! Shipping items must always be handled with care.
	Attach here! The lifting tackle (lashing chain, hoisting belt) is to be attached at the indicated points.
	Avoid touching packages with this symbol when the relative humidity is low, especially if wearing insulating footwear or the floor is non-conductive. Low relative humidity is most common on warm, dry summer days and very cold winter days.

After delivery

Inspect the transport packaging (container, box) for damage.

Important! Fronius International GmbH must be notified immediately of any damage to the packaging. This will expedite the replacement of any damaged parts.



CAUTION!

Risk of damage to property due to the build-up of condensation.

If parts are not unpacked immediately after delivery, moisture can form on or inside the parts (condensation). This can lead to serious damage as a result of the corrosion of parts or to short circuits in electronic/electrical equipment. Ensure that parts are at room temperature before commissioning. Do not attempt to accelerate this process by exposing the parts to a direct heat source. If condensation occurs, the parts must not be used until they have dried out completely (wait five hours).

Temporary storage

Store the parts in a sheltered place that is dry and free from dust.

Storage conditions:

- Never tip
- Avoid heavy impact

If storing for more than three months:

- Oil exposed parts monthly
- Protect parts from dust and moisture

Transport and setup

The total weight of the welding table and system components can be found in the "Machine data" section. The load-carrying equipment used must be designed for this weight. Check its maximum load before lifting the table.

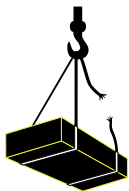

WARNING!

Danger of serious injury from standing under suspended loads

Hoisting, rigging and carrying equipment may be damaged. Falling loads can cause death or serious injury. Body parts can be crushed, fractured or otherwise injured.

- Never stand under a freely suspended load.

- Make absolutely certain that all attachments are fixed and secure before moving the welding table.
- Only use lifting gear with sufficient lifting capacity
- Never use damaged lifting gear
- Do not knot the carrying equipment or lay it over sharp edges
- Always use carrying equipment of the same length
- Move the welding table carefully, avoiding sudden movements
- Set the welding table down carefully

Transport and setup
(continued)



WARNING!

Risk of serious injury and damage from incorrect lifting and transportation procedures.

Incorrect procedures and unsuitable or incorrect devices can cause serious injuries and/or damage.

- Observe national regulations when transporting; lifting equipment, ground conveyors and load-carrying equipment must conform to specifications.
- Use the correct load-carrying equipment for transport and assembly
- Only use the lifting lugs or lifting points specified by the manufacturer to transport the welding table safely.
- Wear gloves and safety footwear when moving the welding table or system components

If the table needs to be moved, a forklift truck must be used to pick it up. Ensure that all connecting leads have been removed. The welding table can also be moved using (optional) wheels.

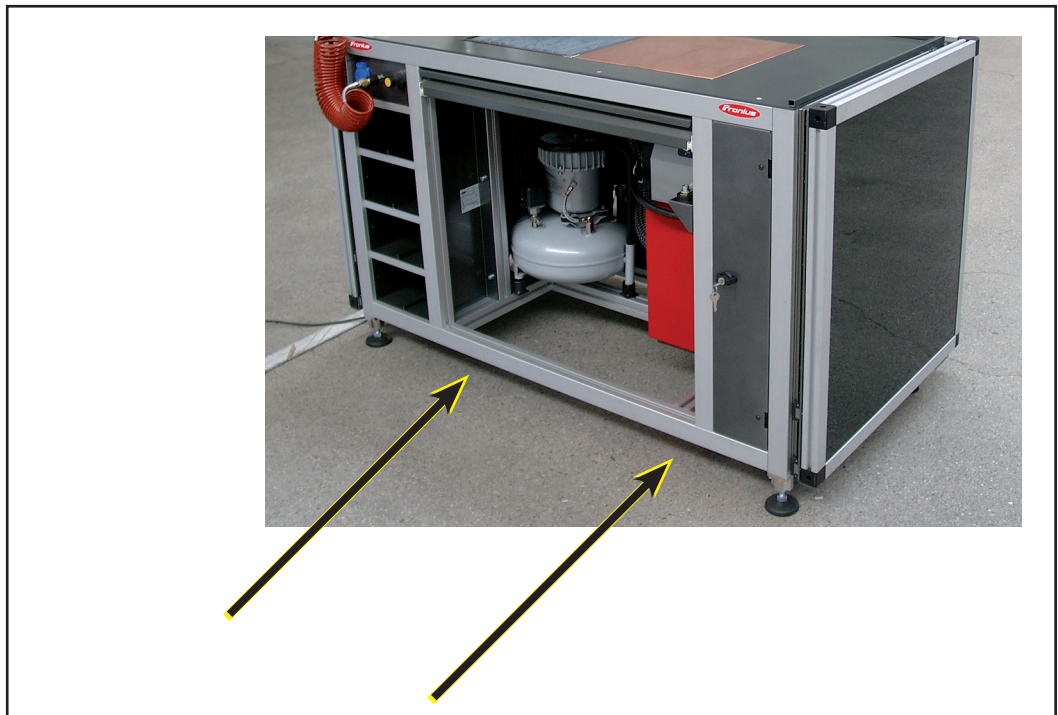

FWT 1500x750 welding table, transportation points

Overview

Overview of the most important functions and features:

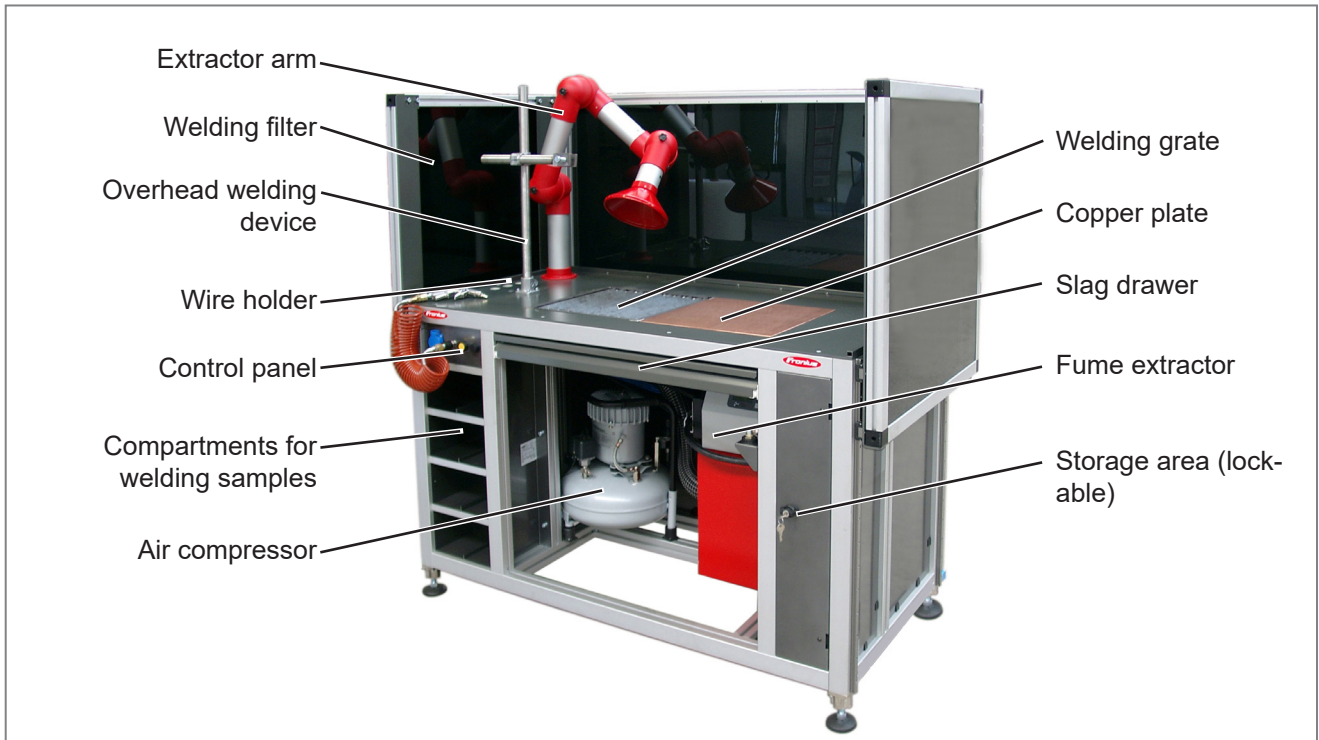

Machine data



DANGER!







Risk of fatal injury from dangerous electrical voltage.

The areas bearing this symbol contain parts that are under dangerous electrical voltages. An electric shock can be fatal.

Work on the electrical system must only be carried out by qualified electrical engineers.



NOTE! The rating plates may not be removed or modified without the consent of Fronius International GmbH. Ensure that the rating plates remain legible.

 A-4600 Wels www.fronius.com		FWT 1500	
		Art.No.:	8,045,282
		Ser.No.:	
EN 12100-1/-2			
 3~ 50 Hz	U ₁	I ₁	
	400 V	16 A	16 A
	weight	p _{max}	P _{1max}
	400 kg	6 bar	11 kVA
L x W x H			
1600 x 830 x 1140 mm			
			

FWT 1500x750 welding table, rating plate

Description of controls and connections

Safety



WARNING!

Operating the equipment incorrectly can cause serious injury and damage.

Do not use the functions described until you have thoroughly read and understood the following documents:

- these operating instructions
- all operating instructions for the system components

External controls and connections

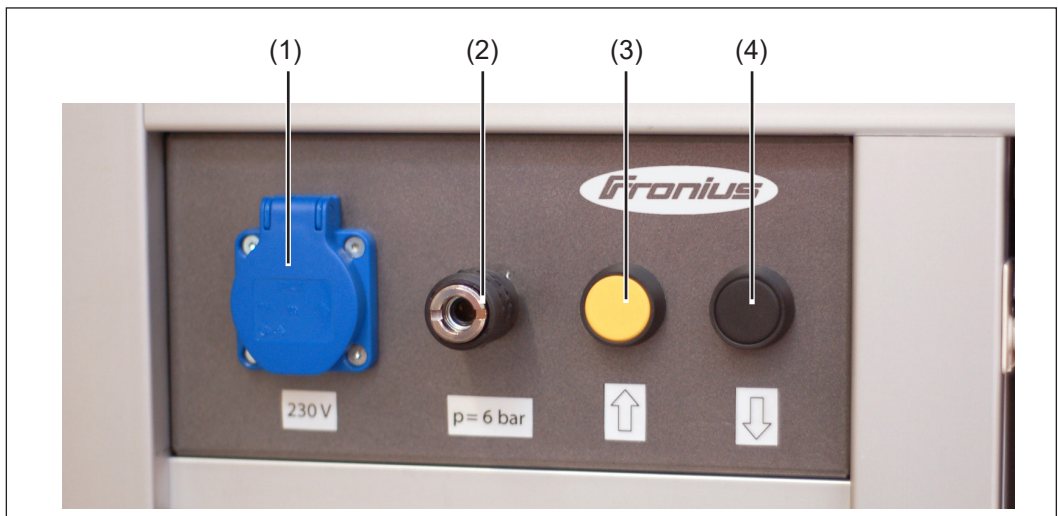

Control panel

(1) 230V socket

For operating additional tools, such as a portable grinder.

(2) Compressed air

Allows a compressed-air gun to be connected easily using a quick-release coupling.

(3) UP key

For raising the eye protector.

(4) DOWN key

For lowering the eye protector.

Maintenance unit



(1) Connection on both sides G1/4

Operating pressure 6 bar

Distributor

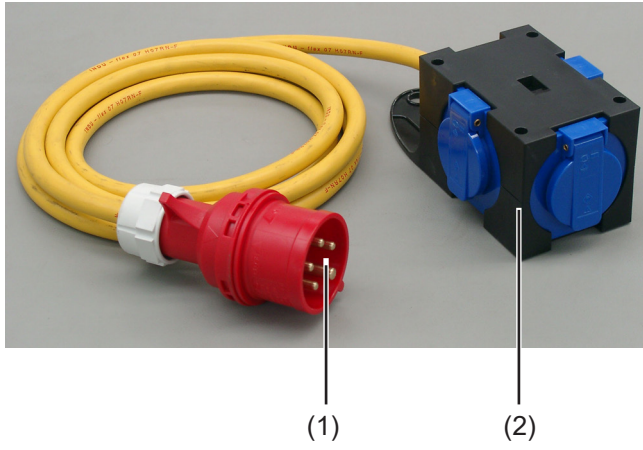

(1) 380V socket
Main connection for the welding table

(2) 230V sockets
For operating installed equipment, such as an extractor or compressor

Extractor See extractor operating instructions

Compressor See compressor operating instructions

Installation and start-up

Start-up

Properties of the installation site

Foundations:

- even and firm

Environment:

- not outdoors
- not in a hazardous area
- not in an area of increased electrical risk (including working in boilers, narrow spaces, in restricted areas, between or on electrically conductive parts, in damp or hot rooms).

Space requirements

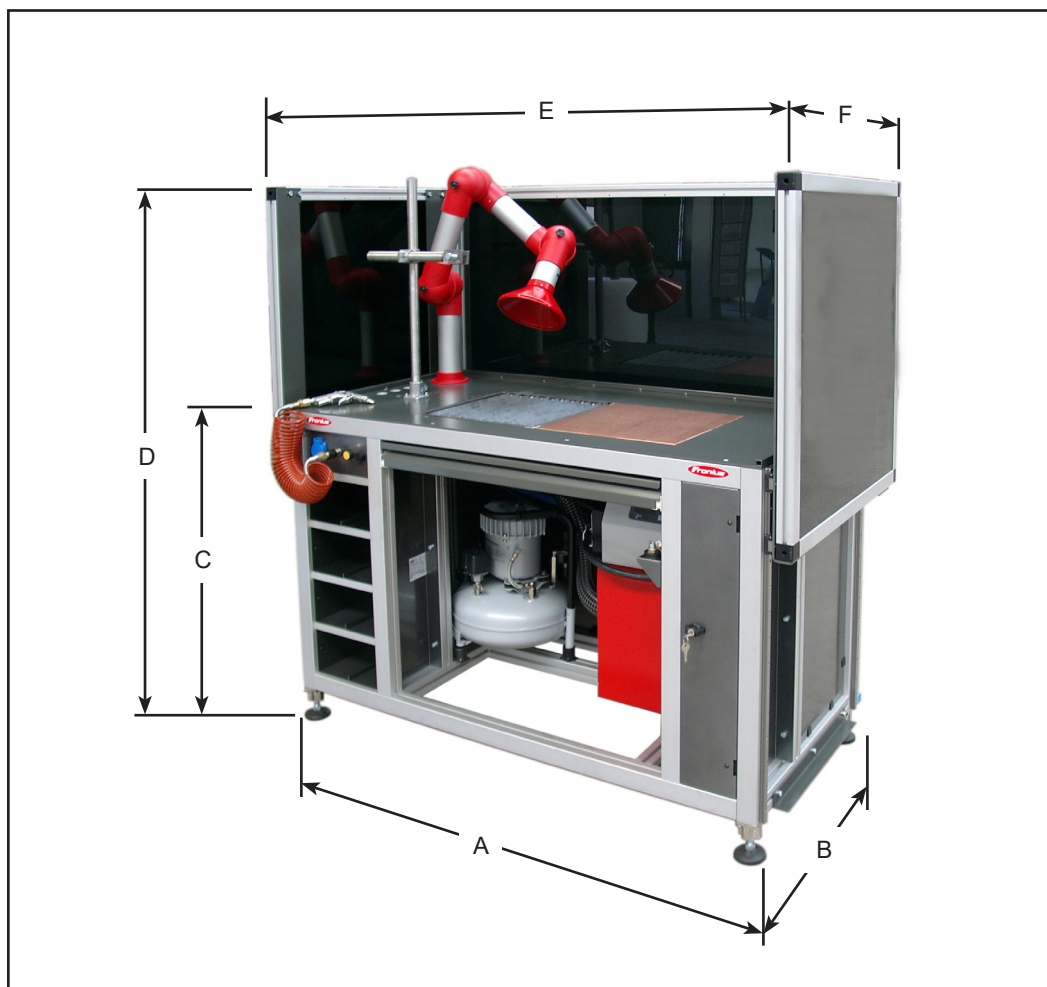

Dimensions

• A	1500 mm
• B	750 mm
• C	945 mm
• D	1780 mm upper position (eye protector)
• D	1140 mm lower position (eye protector)
• E	1600 mm
• F	830 mm

Troubleshooting and maintenance

Troubleshooting

General

In the event of faults, note that the function of the entire system depends on many additional components that are also potential sources of problems.



NOTE! Faults may only be corrected by qualified technicians or by Fronius service personnel.

Safety



WARNING!

An electric shock can be fatal.

Unplug device from the mains before opening it

Basic requirements for the system to work

- Connections established between separate system components
- System components are supplied with electricity and the mains voltage for each component complies with the rating plate
- Pneumatic system is supplied with compressed air at the correct pressure (see rating plate)

Maintenance, service

Safety



WARNING!

Risk of injury and damage during maintenance work.

Before commencing maintenance work:

- Unplug the welding table from the mains
- Switch off all system components and unplug them from the mains
- Ensure that all moving parts are stationary

Maintenance engineers



WARNING!

Risk of injury and damage from incorrectly performed maintenance.

Maintenance work on the welding table must only be carried out by trained specialist technicians. It is essential to adhere to the maintenance operations and intervals. The manufacturer accepts no liability for any damage caused by inadequate or poorly performed maintenance.

Maintenance operations and intervals

Item	Part	Action	Interval
A	Linear guides	Clean, check oil film	M
B	Threaded spindle	Clean, regrease	M
C	Rack and pinion	Clean, regrease	M
D	Toothed belt	Pretension, check for tears	M
E	Current collector	Clean, apply conductive paste	M
F	Earth cable	Check connection	M
G	Rollers and rails	Clean, check position	M
H	Maintenance units	Check filter element and If dirty, change; check liquid level	M
I	Pneumatic/hydraulic systems	Check interconnecting hosepacks and connections, Check guide rods for dirt and check oil film, check maintenance unit	M
J	Linear and rotating components	Clean, function test	M
K	Safety measures:	Function test (EMERGENCY STOP, limit switches, safety strips)	D
L	Bearing units, bearing blocks	Regrease	M
M	Lubricating nipple	Regrease	M
N	Filter mats, ventilation slots	Clean	W
O	Safety glass	Check for damage, replace if necessary	M

DDaily
WWeekly
MMonthly
½Y.....Twice per year
YAnnually

Recommended lubricants

Important! Lubricants with solid lubricant additives (e.g. MoS2, graphite and PTFE) are not suitable for guiding systems.

Lubricant	DIN	DIN number	Remarks
Lubricating grease	KP 2-K	51502 / 51825	Lithium soap-based grease
Lubricating oil	CLP32-100	51517 Part 3	ISO VG 32-100



Safety glass speed can be adjusted by repositioning the exhaust air choke using an angled screwdriver

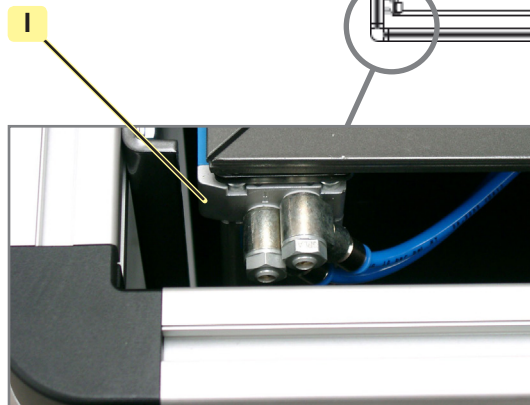
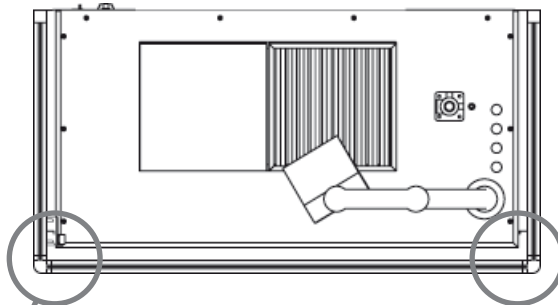

Angled screwdriver



Important! The maintenance activities and maintenance intervals of the following system components can be found in the relevant operating instructions:

- Compressor
- Fume extractor

Spare parts & accessories

Ordering details







NOTE! Only trained technicians may change parts and may only do so after consulting the installation and dismantling instructions supplied.

When ordering spare parts, please provide the following data:

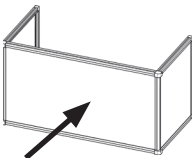
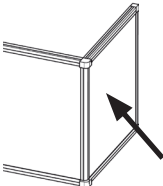
- Exact designation of the spare part
- Associated item number as per spare parts list
- Model name of the device
- Serial number (shown on the rating plate)

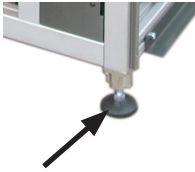

Spare parts

Photo	Item no.	No.	Type	Description
	58,0223,2411	1		Safety glass, front
	58,0223,2410	1		Safety glass, side
	48,0001,0083	1	0.3-10 G1/4	Maintenance unit
	38,0003,0266	1	0.3-10 G1/4	Pressure regulating valve
	48,0007,0202	1	80 / M16x68	Machine foot
	38,0008,0030	1	16A / 400V	Current distribution box



**Spare parts
(continued)**

Photo	Item no.	No.	Type	Description
	48,0002,0198	1		Copper plate
	58,0223,4000	1		Welding grate
	48,0007,0199	1		Lever cylinder lock (incl. 2 keys)
	48,0001,0114	1		Blow-through gun
	48,0001,0113	1	DM6 7.5m	Spiral hose (pneu- matic)

Accessories

Photo	Item no.	No.	Type	Description
	8,100,119	1		Fume extractor (incl. extractor arm, extrac- tor hood, automatic start/stop)
	8,100,120	1		Air compressor (incl. blow-through gun and spiral hose)
	8,100,0121	1	2x castors 2x castors with locks	Wheels incl. installa- tion materials

**Accessories
(continued)**

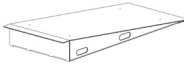
Photo	Item no.	No.	Type	Description
	38,0008,0027	1	32A / 400V	Current connection distributor
	38,0100,0189	1		Earth cable distributor (x5)
	48,0009,0038	1		Swivel stool (symbol photo)
no image	on request	1	country-specific version	Transport box
	58,0223,F000	1		Ramp (for transport box)

Annex

Declaration of conformity



EU-KONFORMITÄTSERKLÄRUNG 2016 EU-DECLARATION OF CONFORMITY 2016 DÉCLARATION UE DE CONFORMITÉ, 2016

Wels-Thalheim, 2016-04-20

Die Firma

Manufacturer

La compagnie

FRONIUS INTERNATIONAL GMBH

Froniusplatz 1, 4600 Wels

erklärt in alleiniger Verantwortung,
dass folgendes Produkt:

Hereby certifies on its sole
responsibility that the following
product:

se déclare seule responsable du fait
que le produit suivant:

FWT
Schweißzubehör

FWT
Arc welding equipment

FWT
Accessoires de soudage

auf das sich diese Erklärung
bezieht, mit folgenden Richtlinien
bzw. Normen übereinstimmt:

which is explicitly referred to by this
Declaration meet the following
directives and standard(s):

qui est l'objet de la présente
déclaration correspondent aux
suivantes directives et normes:

Richtlinie 2006/42/EG
Maschinenrichtlinie

Directive 2006/42/EC
Machinery Directive

Directive 2006/42/CE
Directive aux machines

Richtlinie 2014/35/EU
Elektrische Betriebsmittel
Niederspannungsrichtlinie

Directive 2014/35/EU
Electrical Apparatus
Low Voltage Directive

Directive 2014/35/UE
Outillages électriques
Directive de basse tension

Richtlinie 2011/65/EU
RoHS

Directive 2011/65/EU
RoHS

Directive 2011/65/UE
RoHS

Europäische Normen inklusive
zutreffende Änderungen
EN ISO 12100:2010
EN 60204-1:2006

European Standards including
relevant amendments
EN ISO 12100:2010
EN 60204-1:2006

Normes européennes avec
amendements correspondants
EN ISO 12100:2010
EN 60204-1:2006

Die oben genannte Firma hält
Dokumentationen als Nachweis der
Erfüllung der Sicherheitsziele und
die wesentlichen Schutzanforder-
ungen zur Einsicht bereit.

Documentation evidencing
conformity with the requirements of
the Directives is kept available for
inspection at the above
Manufacturer.

En tant que preuve de la satisfaction
des demandes de sécurité la
documentation peut être consultée
chez la compagnie susmentionnée.

Dokumentationsverantwortlicher:
(technische Dokumentation)

person responsible for documents:
(technical documents)

responsable documentation:
(technique documentation)

Ing. Josef Feichtinger
Günter Fronius Straße 1
A - 4600 Wels-Thalheim

Ing. Josef Feichtinger
Günter Fronius Straße 1
A - 4600 Wels-Thalheim

Ing. Josef Feichtinger
Günter Fronius Straße 1
A - 4600 Wels-Thalheim

CE 2016

ppa. Mag. Ing. H. Hackl
Member of Board
Chief Technology Officer

Pneumatic plan

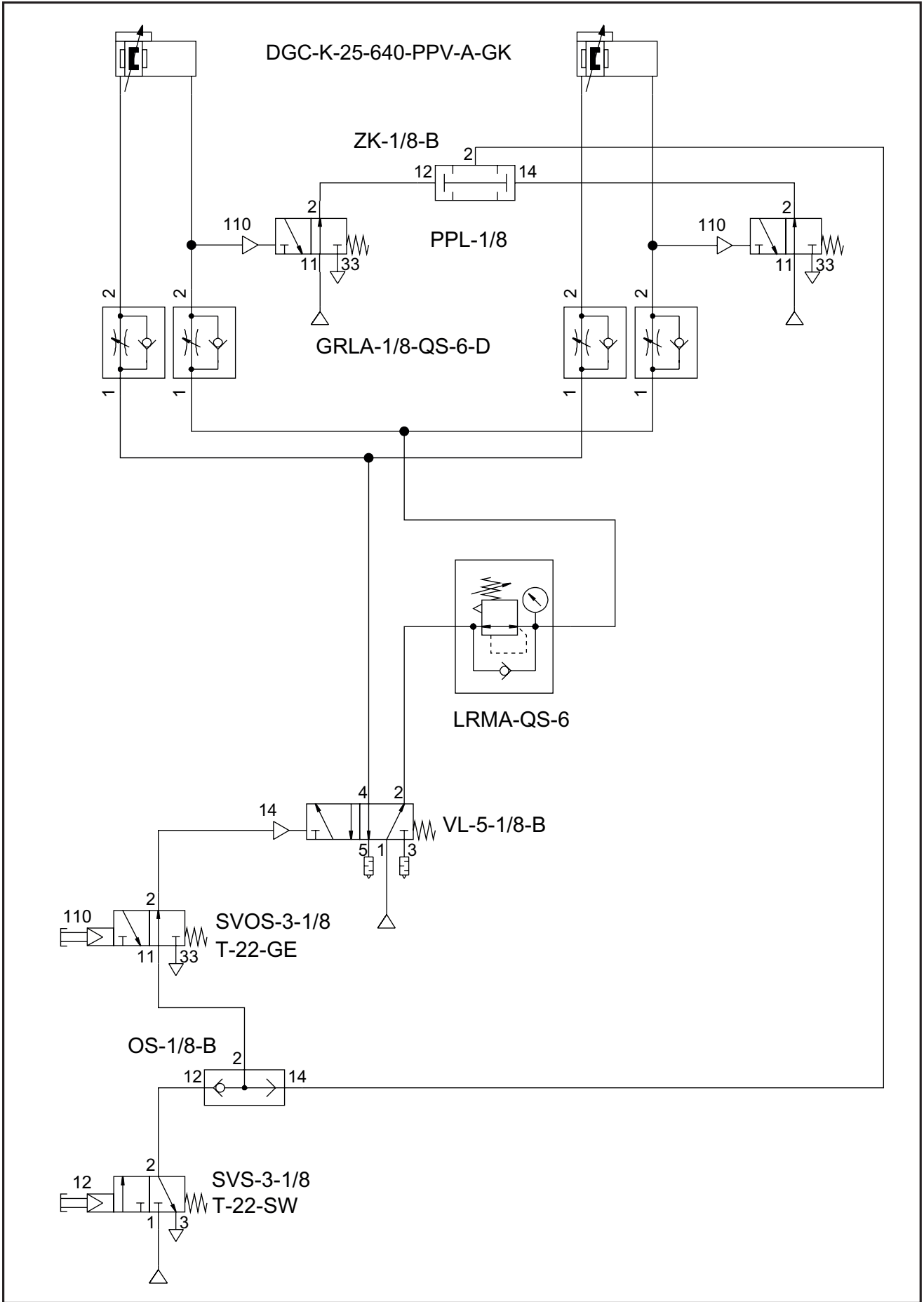



FRONIUS INTERNATIONAL GMBH
TechSupport Automation

Froniusplatz 1, A-4600 Wels, Austria

E-Mail: support.automation@fronius.com
www.fronius.com

www.fronius.com/addresses

Under <http://www.fronius.com/addresses> you will find all addresses
of our Sales & service partners and Locations.